

2-5/8" X 4" X 8" INVISI-LUG™ PAVER

PATENT PENDING

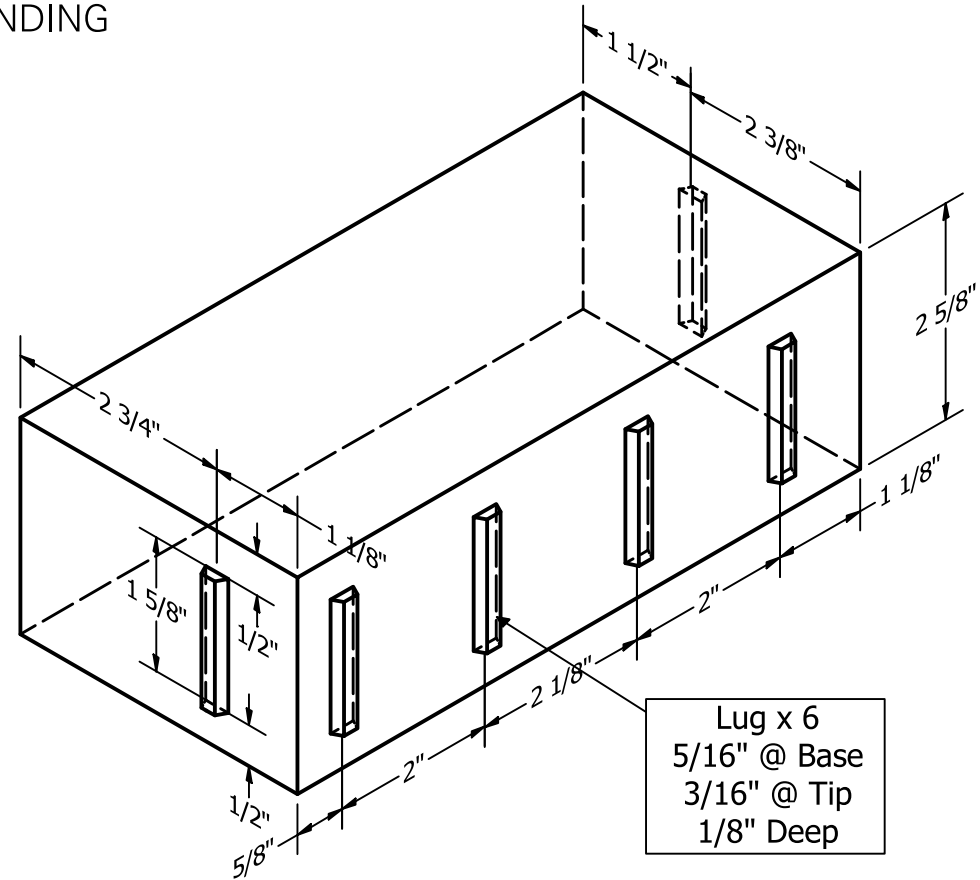
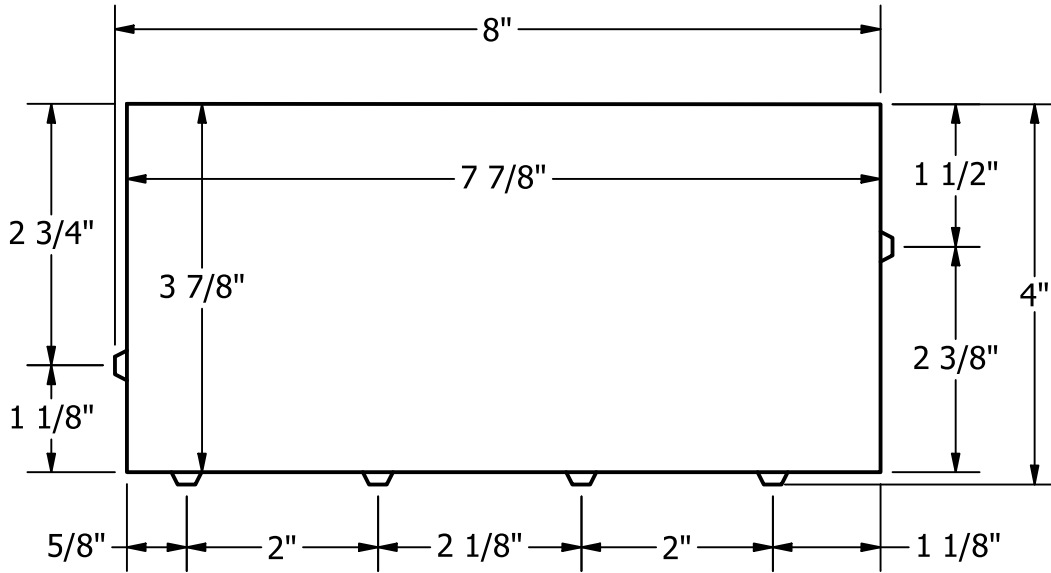

NOT ALL PRODUCTS ARE AVAILABLE IN ALL COLORS AND/OR SIZE. PLEASE CONTACT ENDICOTT FOR AVAILABILITY.

ENDICOTT INVISI-LUG™ PAVERS CONFORM TO ASTM C902 SPECIFICATIONS.

