



ENDICOTT

COLLECTION

FACE BRICK

THIN BRICK

CLAY PAVERS

BUILDING LEGACIES FROM THE GROUND UP.



THE MOMENT WHEN IT ALL COMES TOGETHER.

A GREAT IDEA, THE RIGHT MATERIAL, A NEW
BEGINNING. AT ENDICOTT, OUR BRICK AND
PAVERS, ONE BY ONE, HAVE BEEN LAYING
THE FOUNDATION FOR GREAT ARCHITECTURE
FOR OVER 100 YEARS.

TABLE OF CONTENTS

FACE BRICK

Featured Projects	4-11
Colors	12-17
Textures	18-20
Sizes	21

THIN BRICK

Featured Projects	22-29
Colors	30-33
Textures	34-36
Applications	37
Sizes	38-39
Glazed	40-41

CLAY PAVERS

Featured Projects	42-49
Colors	50-51
Sizes	52
Spacers	53

Brick Colors: Manganese Ironspot, Sienna Ironspot, Dark Sandstone, Light Sandstone

Bruce D. Nesbitt African American Cultural Center – Champaign, IL

ST. GREGORY THE GREAT CATHOLIC CHURCH



MARYSVILLE
KANSAS



PROJECT DETAILS

COLOR

Medium Ironspot #46

SIZE

Modular
Shapes

TEXTURE

Velour

DEBRUCE HALL KC ART INSTITUTE



KANSAS CITY
MISSOURI



PROJECT DETAILS

COLOR

Manganese Ironspot

SIZE

Modular
Shapes

TEXTURE

Velour

PEABODY WALK LOFTS



BALTIMORE
MARYLAND



PROJECT DETAILS

COLOR

Ravenswood Ironspot

SIZE

Modular
Shapes

TEXTURE

Velour

ST. MARY'S CHAPEL



LIVONIA
MICHIGAN



PROJECT DETAILS

COLOR

Dark Ironspot

SIZE

Modular
Shapes

TEXTURE

Smooth

ARCHITECTURAL SERIES



Golden Buff



Light Grey Blend

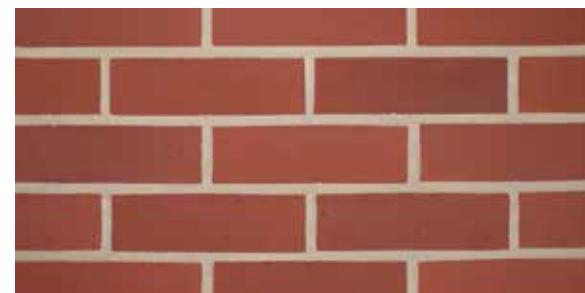

Ruby Red



Red Ironspot



Executive Ironspot



Sienna Ironspot



Grey Blend



Light Sandstone



Desert Ironspot Light



Desert Ironspot Dark



Medium Ironspot #77



Medium Ironspot #46



Dark Sandstone



Rose Blend



Coppertone



Copper Canyon



Dark Ironspot



Ravenswood Ironspot



Red Blend



Burgundy Blend



Bordeaux Blend



Manganese Brown



Manganese Ironspot

RESIDENTIAL SERIES

FACE BRICK



Grey Sands



Adobe Sands Heritage



Autumn Sands Heritage



Heritage #46 no Yellow



Copper Sands Heritage



Grey Heritage with Black



Heritage #46



Sahara Sands Heritage*



Orleans Sands Heritage



Burgundy Sands Heritage*



Merlot Sands Antique

* Can be done in square edge/no texture.



Brick Color: Burgundy Sands

Residence – Omaha, NE

TEXTURES

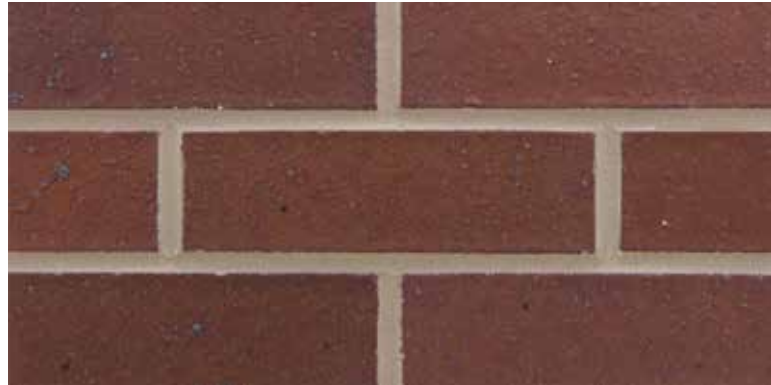

Smooth



Velvetex



Velour



Vertical Score



Matt



Artisan

TEXTURES



Heritage



Antique

SIZES

NORMAN

3-5/8" x 2-1/4" x 11-5/8"

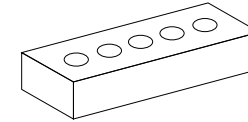

ROMAN

3-5/8" x 1-5/8" x 11-5/8"

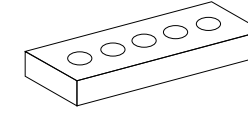

MODULAR

3-5/8" x 2-1/4" x 7-5/8"

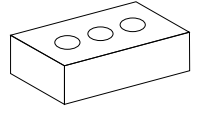

SLIM KINGSIZE

2-5/8" x 2-5/8" x 9-5/8"

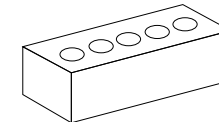

KINGSIZE

3" x 2-5/8" x 9-5/8"

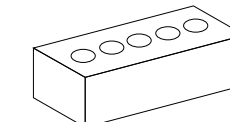

NORWEGIAN

3-5/8" x 2-13/16" x 11-5/8"

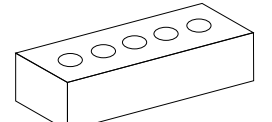

ENGINEER MODULAR

3-5/8" x 2-13/16" x 7-5/8"

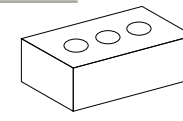

ENGINEER KINGSIZE

3" x 2-13/16" x 9-5/8"

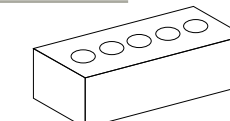

CLOSURE

3-5/8" x 3-5/8" x 7-5/8"

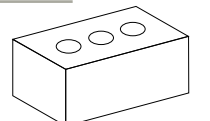

MERIDIAN

3-5/8" x 3-5/8" x 15-5/8"

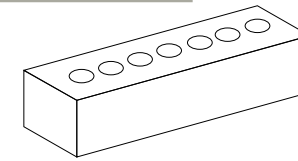

3" UTILITY

3" x 3-5/8" x 11-5/8"

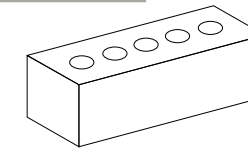

UTILITY

3-5/8" x 3-5/8" x 11-5/8"

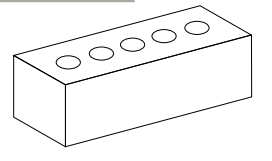

2-1/4" MERIDIAN

3-5/8" x 2-1/4" x 15-5/8"

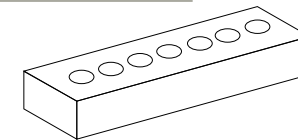

6" THRU THE WALL

5-5/8" x 3-5/8" x 11-5/8"

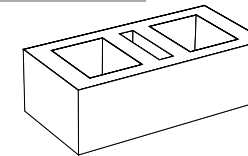

8" THRU THE WALL

7-5/8" x 3-5/8" x 11-5/8"

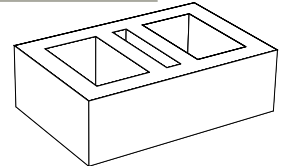

TRIPLE BRICK

3-5/8" x 7-5/8" x 7-5/8"

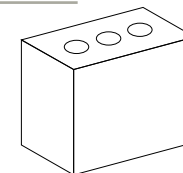

BOSTON COLLEGE FISH FIELD HOUSE



CHESTNUT HILL
MASSACHUSETTS



PROJECT DETAILS

COLOR

Desert Ironspot Dark
Coppertone

SIZE

Modular

TEXTURE

Velour

800 FULTON MARKET



CHICAGO
ILLINOIS



PROJECT DETAILS

COLOR

Burgundy Blend
Red Blend
Rose Blend
Ruby Red

SIZE

2-1/4" Meridian

TEXTURE

Velour

DC WEST ELEMENTARY SCHOOL



VALLEY
NEBRASKA

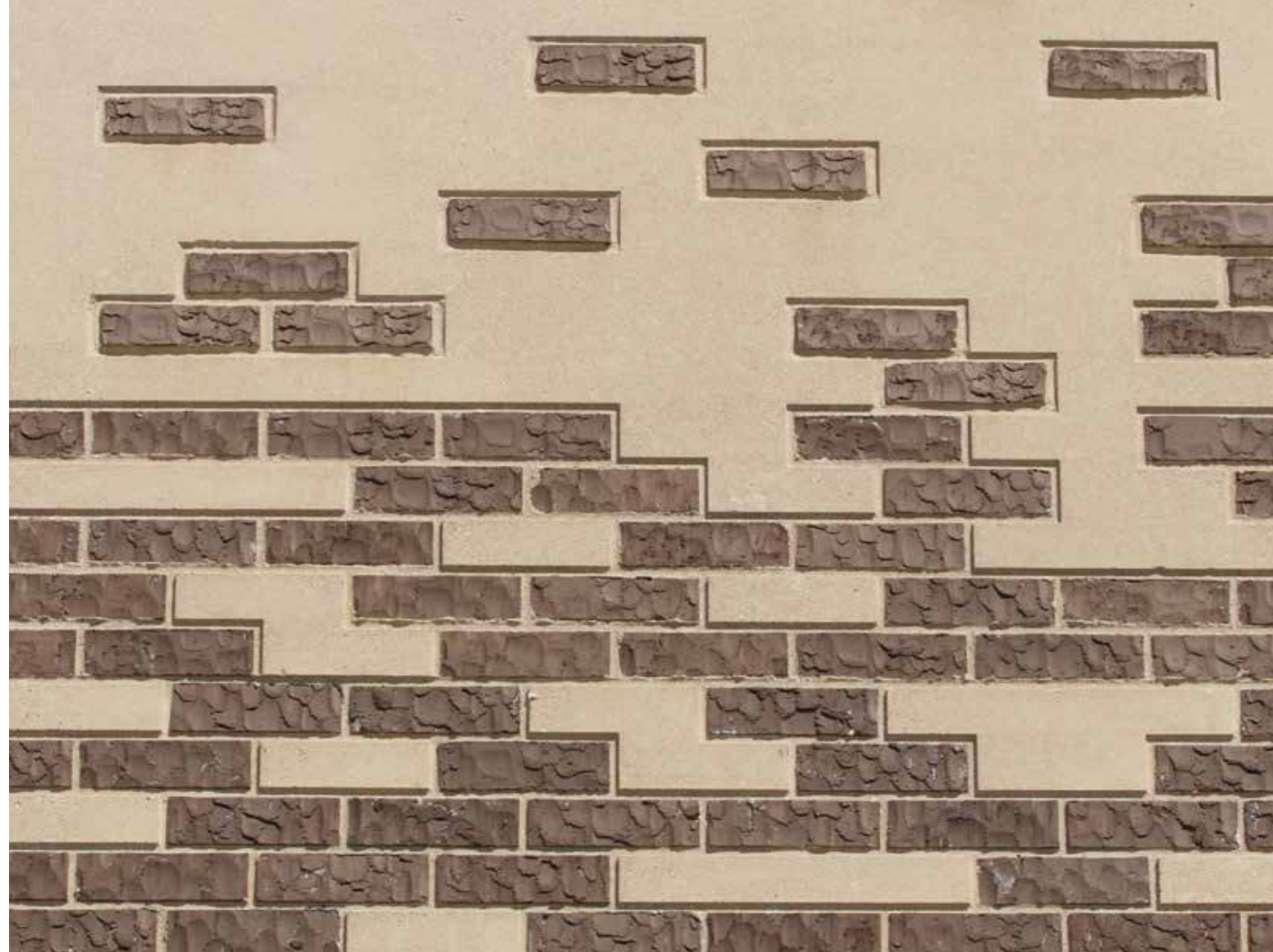

PROJECT DETAILS

COLOR

Dark Sandstone

SIZE

Modular

TEXTURE

Artisan

HEART MINISTRY CENTER



OMAHA
NEBRASKA



PROJECT DETAILS

COLOR

Sienna Ironspot

SIZE

Roman

TEXTURE

Smooth

COLORS



Ivory Blend



Golden Buff



Red Blend



Burgundy Blend



Light Grey Blend



Grey Blend

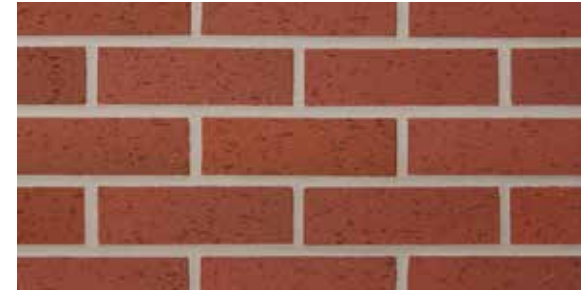

Ruby Red



Red Ironspot



Light Sandstone



Dark Sandstone



Desert Ironspot Light



Desert Ironspot Dark



Buff Blend



Rose Blend



Coppertone



Copper Canyon

COLORS



Bordeaux Blend



Manganese Brown



Grey Sands



Merlot Sands



Executive Ironspot



Sienna Ironspot



Burgundy Sands



Sahara Sands



Medium Ironspot #77



Medium Ironspot #46



Autumn Sands



Dark Ironspot



Manganese Ironspot



Orleans Sands

TEXTURES



Available in 1/2", 5/8" and 1" thick.

Smooth



Available in:
• 5/8" thick
• Modular and Closure

Vertical Score



Available in 1/2" and 1" thick.

Velour



Available in:
• 5/8" thick
• Modular and Closure

Artisan



Available in:
• 5/8" thick
• Modular and Closure

Matt



Available in 5/8" and 1" thick.

Heritage

TEXTURES



Available in 1/2" thick.

Square Edge no Texture



KEYBACK DESIGN

To enhance in-place installation, Endicott thin brick features a keyback design, which provides a mechanical lock into the concrete for maximum durability and permanence.

It also provides the advantage of increased freeze-thaw pull-out strength.

APPLICATIONS

Some of the more common application processes for thin brick include:

PANEL SYSTEM Prefabricated or On-Site Panelization

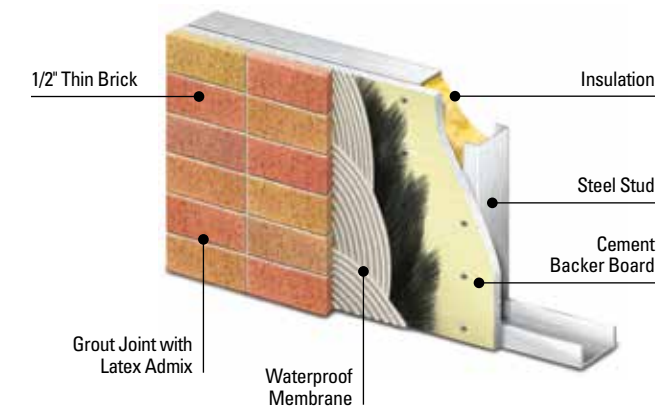

METAL PANEL WALL SYSTEM Prefabricated or On-Site Panelization

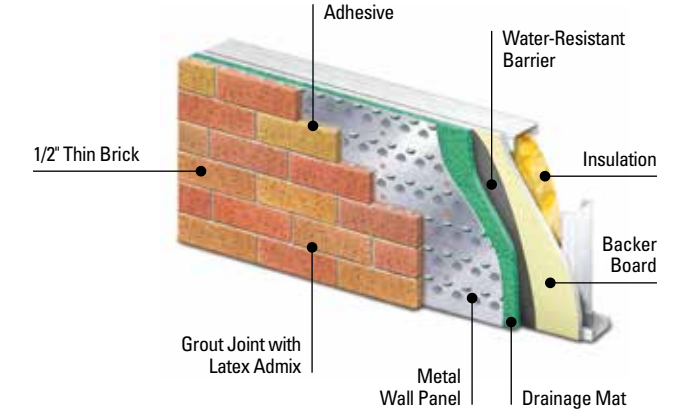

THIN BED SYSTEM WITH LEVELING COAT Job Applied Over Precast or Poured in Place Concrete

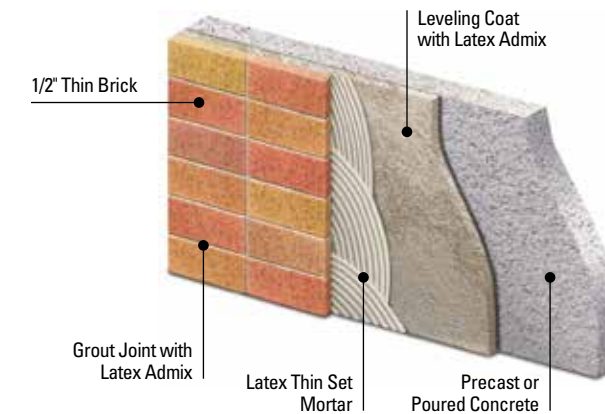

THIN BRICK SYSTEM Embedded in Precast Concrete

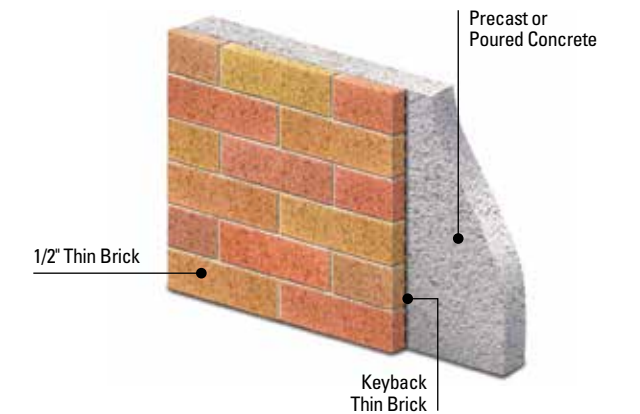

MORTAR BED SYSTEM Prefabricated or On-Site Panelization

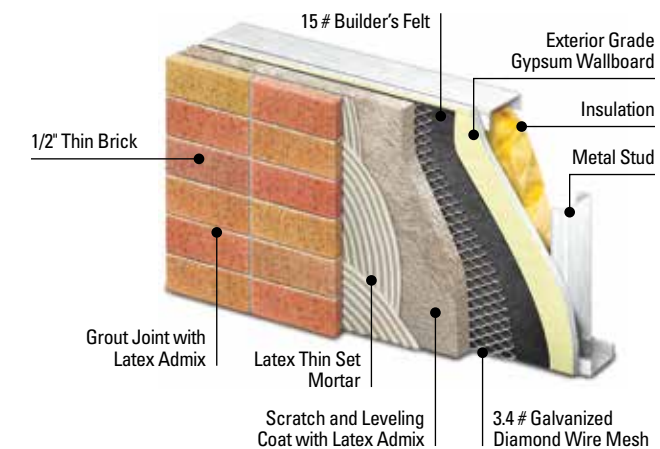

MORTAR BED SYSTEM Concrete Block Infill Wall or Existing Masonry

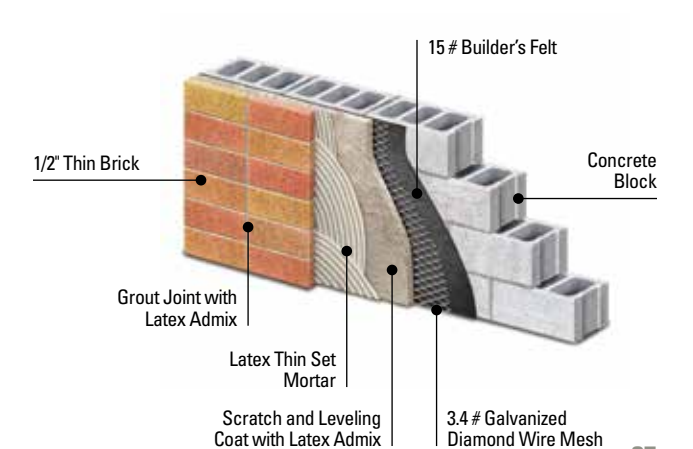

SIZES

ROMAN

1-5/8" x 11-5/8"

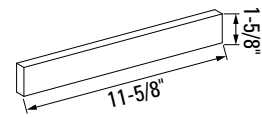

MODULAR

2-1/4" x 7-5/8"

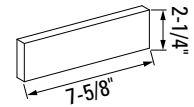

NORMAN

2-1/4" x 11-5/8"

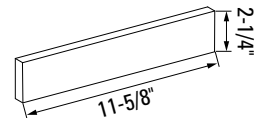

BC448

3-5/8" x 7-5/8" x 3-5/8"

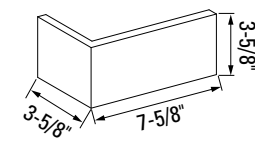

BC4412

3-5/8" x 11-5/8" x 3-5/8"

NOTE: Available in 1" thick only.

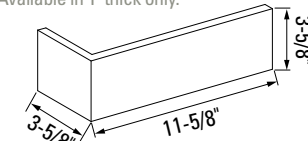

BC848

3-5/8" x 7-5/8" x 7-5/8"

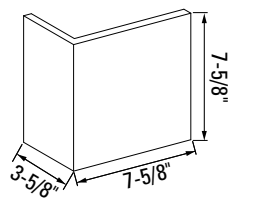

2-1/4" MERIDIAN

2-1/4" x 15-5/8"

NOTE: Available in 1" thick only.

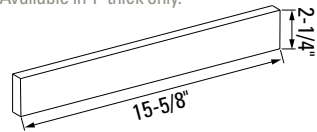

3-5/8" MERIDIAN

3-5/8" x 15-5/8"

NOTE: Available in 1" thick only.

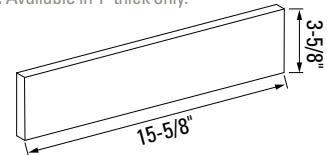

KINGSIZE

2-5/8" x 9-5/8"

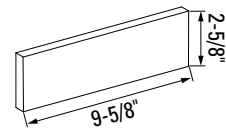

EDGE CAP A

3-5/8" x 7-5/8" x 2-1/4"

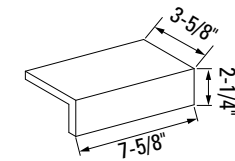

EDGE CAP B

3-5/8" x 11-5/8" x 2-1/4"

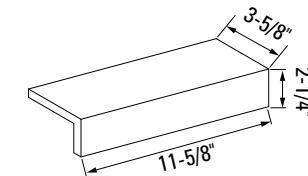

EDGE CAP C

3-5/8" x 7-5/8" x 3-5/8"

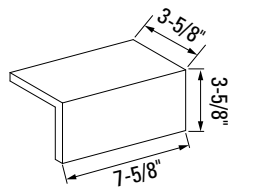

CLOSURE

3-5/8" x 7-5/8"

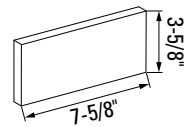

UTILITY

3-5/8" x 11-5/8"

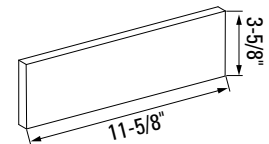

TRIPLE

7-5/8" x 7-5/8"

NOTE: Available in 1/2" and 5/8" thick only.

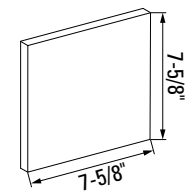

EDGE CAP D

3-5/8" x 11-5/8" x 3-5/8"

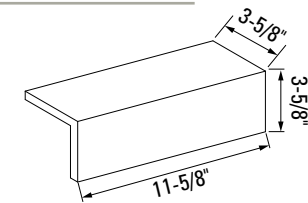

EDGE CAP E

2-1/4" x 7-5/8" x 2-1/4"

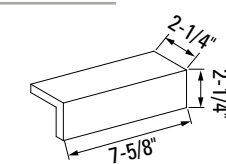

EDGE CAP F

2-1/4" x 11-5/8" x 2-1/4"

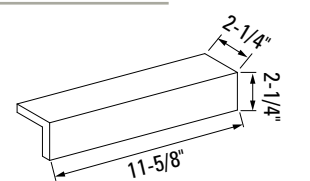

BC1-5/8" 48

3-5/8" x 7-5/8" x 1-5/8"

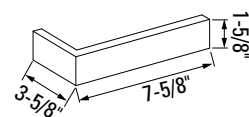

BC1-5/8" 412

3-5/8" x 11-5/8" x 1-5/8"

NOTE: Available in 1" thick only.

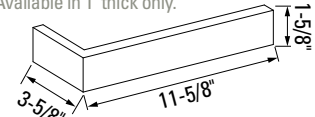

BC2-1/4" 48

3-5/8" x 7-5/8" x 2-1/4"

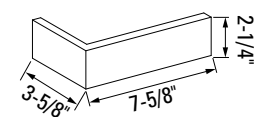

EDGE CAP G

3-5/8" x 11-5/8" x 1-5/8"

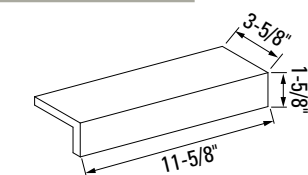

EDGE CAP H

1-5/8" x 11-5/8" x 1-5/8"

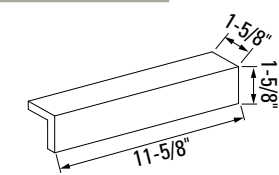

EDGE CAP CORNERS

Left/Right

NOTE: 3-Sided L/R dimensions are the same as Edge Caps shown.

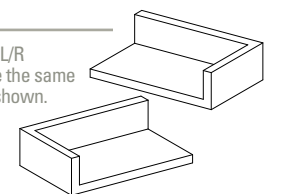

BC2-1/4" 412

3-5/8" x 11-5/8" x 2-1/4"

NOTE: Available in 1" thick only.

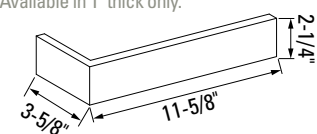

BC2-5/8" 310

3" x 9-5/8" x 2-5/8"

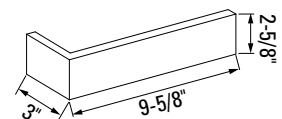

ROLOK SILL

2-1/4" x 3-1/2" x 3-5/8"

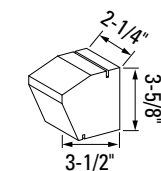

ROLOK SILL INTERNAL CORNER

4-1/2" x 2-1/2" x 3-5/8"

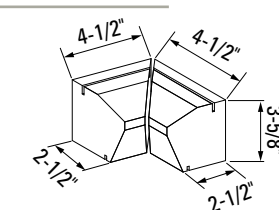

ROLOK SILL EXTERNAL CORNER

2-1/4" x 4-3/4" x 3-5/8"

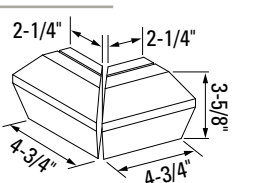

GLAZED SERIES



SN-1



SN-2



VC-1



VC-2



SN-3



SN-4

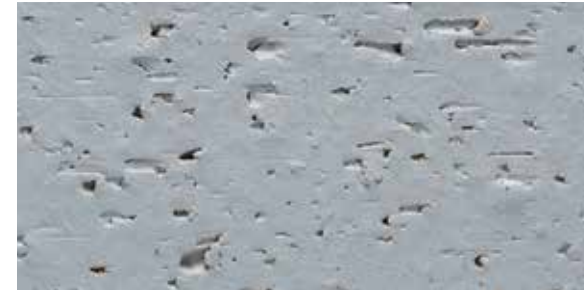

VC-3

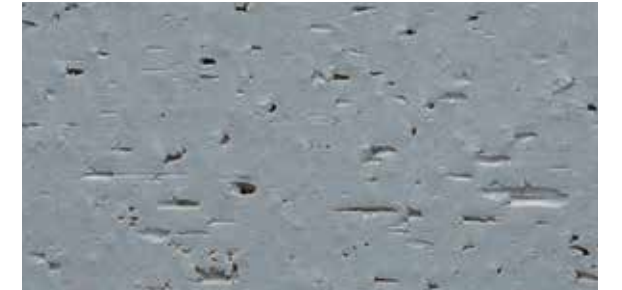

VC-4



SN-5



SN-6



VC-5



VC-6

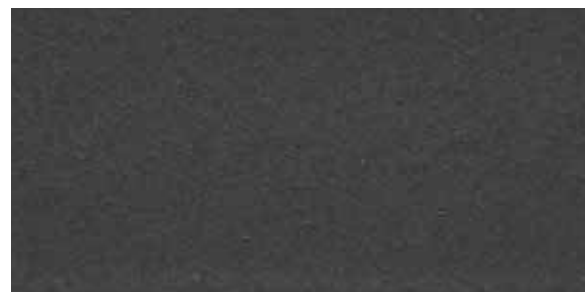

SN-7

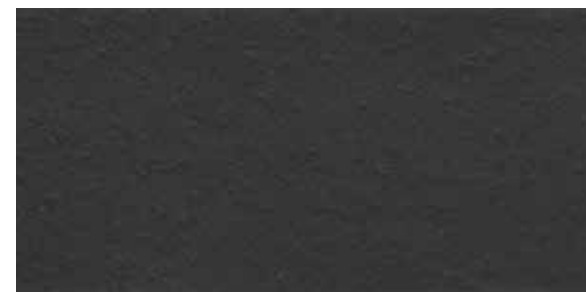

SN-8

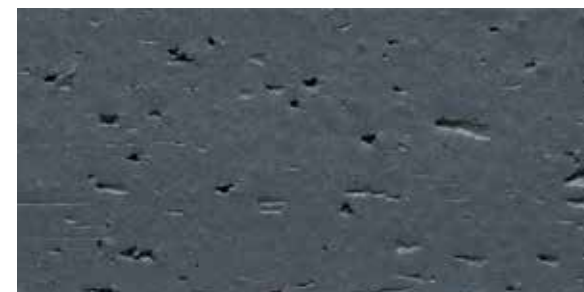

VC-7



VC-8

VILLANOVA UNIVERSITY



VILLANOVA
PENNSYLVANIA



PROJECT DETAILS

COLOR

Dark Ironspot
Medium Ironspot #46
Manganese Ironspot

SIZE/STYLE

2-5/8" x 4" x 8" Relieved/Lugged
2-5/8" x 4" x 8" Permeable

DUBLIN STREETSCAPE



DUBLIN
OHIO



PROJECT DETAILS

COLOR

Medium Ironspot #46
Manganese Ironspot
Dark Ironspot

SIZE/STYLE

4" x 8" Relieved/Lugged
4" x 8" Square Edge
4" x 8" Permeable

CITADEL OUTLETS MALL



LOS ANGELES
CALIFORNIA



PROJECT DETAILS

COLOR

- Medium Ironspot #46
- Dark Ironspot
- Medium Ironspot #77
- Bordeaux Blend
- Coppertone
- Copper Canyon

SIZE/STYLE

4" x 8" Relieved Lugged

CREIGHTON UNIVERSITY ROUNDAABOUT



OMAHA
NEBRASKA



PROJECT DETAILS

COLOR

Burgundy Blend
Red Blend
Rose Blend
Medium Ironspot #77

SIZE/STYLE

2-5/8" x 4" x 8" Relieved/Lugged

COLORS



Rose Blend



Red Blend



Medium Ironspot #77



Medium Ironspot #46



Burgundy Blend



Bordeaux Blend



Dark Ironspot



Manganese Ironspot



Coppertone



Copper Canyon

SIZES

4 x 8 PAVER

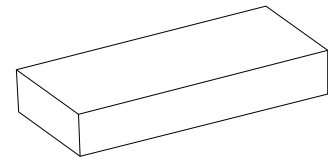

1-1/4" x 3-5/8" x 7-5/8" 2-1/4" x 3-5/8" x 7-5/8"
1-1/4" x 4" x 8" 2-1/4" x 4" x 8"

8 x 8 PAVER

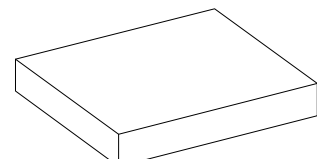

2-1/4" x 8" x 8"

2-5/8 x 4 x 8 PAVER

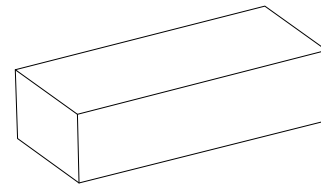

2-5/8" x 4" x 8"

4 x 12 PAVER

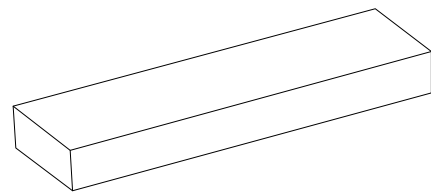

2-1/4" x 3-5/8" x 11-5/8"
2-1/4" x 4" x 12"

4 x 8 PERMEABLE PAVER

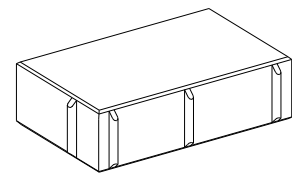

2-1/4" x 4" x 8"
*Lug sizes and configurations may vary.

2-5/8 x 4 x 8 PERMEABLE PAVER

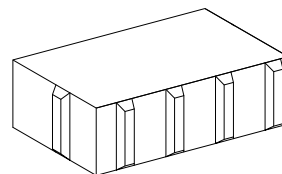

Effective: 2-5/8" x 4" x 8"
Actual: 2-7/8" x 4" x 8"
*Lug sizes and configurations vary.

ADA HANDICAP DETECTABLE WARNING PAVER

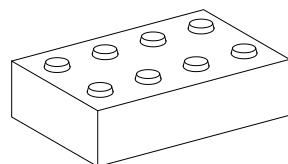

2-1/4" x 3-5/8" x 7-5/8"
2-1/4" x 4" x 8"

4 x 8 RELIEVED EDGE LUGGED PAVER

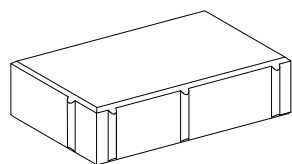

2-1/4" x 4" x 8"
*Lug sizes and configurations may vary.

2-5/8 x 4 x 8 RELIEVED EDGE LUGGED PAVER

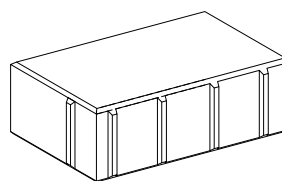

Effective: 2-5/8" x 4" x 8"
Actual: 2-7/8" x 4" x 8"
*Lug sizes and configurations may vary.

PAVER STEP TREAD

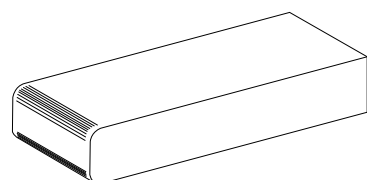

2-1/4" x 3-5/8" x 7-5/8"
2-1/4" x 3-5/8" x 11-5/8"

SPACERS

HERRINGBONE

Paver Spacers used in a herringbone application



RUNNING BOND

Paver Spacers used in a running bond application



BASKETWEAVE

Paver Spacers used in a basketweave application



ELIMINATING CHIPPAGE

In segmental paving applications, chippage often occurs when pavers move against each other due to improper installation techniques. Endicott paver spacers, however, eliminate this issue. They create and ensure the needed spacing between units to accommodate jointing sand while providing the crisp appearance of square edge pavers.

ESTIMATING DATA

HERRINGBONE PATTERN

10 'T' Spacers/sq. ft.

RUNNING BOND PATTERN

10 'T' Spacers/sq. ft.

BASKETWEAVE PATTERN

9 'T' Spacers/sq. ft.

1 '+' Spacers/sq. ft.

PAVER SPACER: CROSS

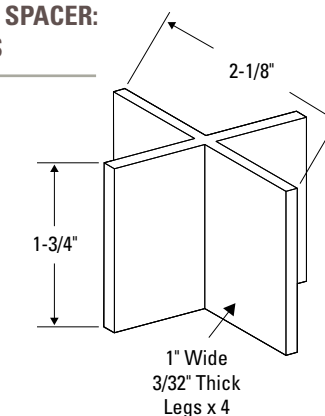

PAVER SPACER: TEE

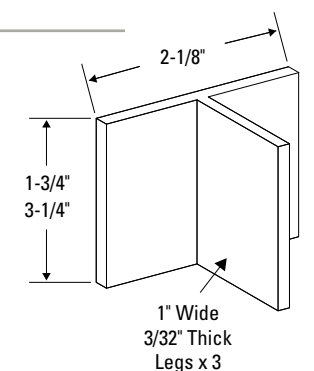

NOTE: Above sq. ft. quantities include perimeter spacers.



Endicott Clay Products Company

P.O. Box 17 Fairbury, Nebraska USA 68352
P 402.729.3315 F 402.729.5804

Endicott Thin Brick & Tile, LLC

P.O. Box 645 Fairbury, Nebraska USA 68352
P 402.729.3323 F 402.729.5804

For other literature, samples and the name of your nearest distributor, contact Endicott today.

