

CLAY PAVERS



NATURAL COLORFAST BEAUTY

A step above hardscape alternatives, the natural colorfast beauty of Endicott clay pavers empowers you to build your design vision from the ground up.

WHERE FORM
MEETS
FUNCTION.

ENDICOTT

NOTHING EXEMPLIFIES THE IDEA OF “WHERE FORM MEETS FUNCTION” BETTER THAN CLAY PAVERS FROM ENDICOTT. AS DURABLE AS THEY ARE STUNNING, AS INSPIRING AS THEY ARE PRACTICAL, ENDICOTT CLAY PAVERS ARE FORMED FROM NATURAL, COLORFAST MATERIALS AND FIRED AT TEMPS EXCEEDING 2,000 DEGREES FAHRENHEIT TO RESIST WEAR, COLOR-FADING, AND STAINING.

Paver Colors: Medium Ironspot #46 and #77, Dark Ironspot, Bordeaux Blend, Rose Blend

Outlets at San Clemente – San Clemente, CA

VILLANOVA UNIVERSITY



VILLANOVA
PENNSYLVANIA



PROJECT DETAILS

COLOR

Dark Ironspot
Medium Ironspot #46
Manganese Ironspot

SIZE/STYLE

2-5/8" x 4" x 8" Relieved/Lugged
2-5/8" x 4" x 8" Permeable

DUBLIN STREETSCAPE



DUBLIN
OHIO



PROJECT DETAILS

COLOR

Medium Ironspot #46
Manganese Ironspot
Dark Ironspot

SIZE/STYLE

4" x 8" Relieved/Lugged
4" x 8" Square Edge
4" x 8" Permeable

OUTLETS AT SAN CLEMENTE



SAN CLEMENTE
CALIFORNIA



PROJECT DETAILS

COLOR

Medium Ironspot #46
Dark Ironspot
Medium Ironspot #77
Bordeaux Blend
Rose Blend
Red Blend
Coppertone
Copper Canyon
Burgundy Blend

SIZE/STYLE

4" x 8" Lugged

COLORS



Rose Blend



Red Blend



Medium Ironspot #77



Medium Ironspot #46



Burgundy Blend



Bordeaux Blend



Dark Ironspot



Manganese Ironspot



Coppertone



Copper Canyon

SIZES

4 x 8 PAVER

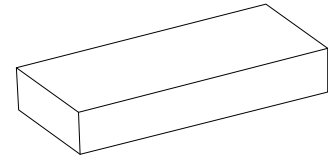

1-1/4" x 3-5/8" x 7-5/8"
1-1/4" x 4" x 8"

8 x 8 PAVER

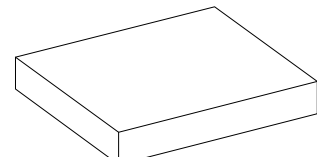

2-1/4" x 8" x 8"

2-5/8 x 4 x 8 PAVER

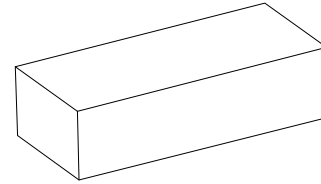

2-5/8" x 4" x 8"

4 x 12 PAVER

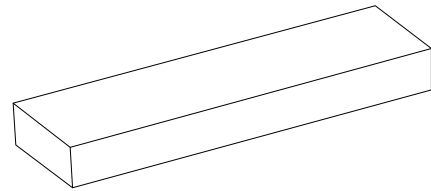

2-1/4" x 3-5/8" x 11-5/8"
2-1/4" x 4" x 12"

4 x 8 PERMEABLE PAVER

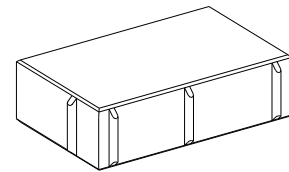

2-1/4" x 4" x 8"
*Lug sizes and configurations may vary.

2-5/8 x 4 x 8 PERMEABLE PAVER

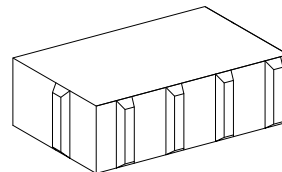

Effective: 2-5/8" x 4" x 8"
Actual: 2-7/8" x 4" x 8"
*Lug sizes and configurations vary.

ADA HANDICAP DETECTABLE WARNING PAVER

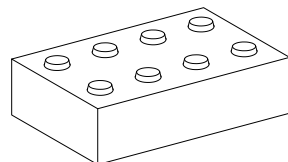

2-1/4" x 3-5/8" x 7-5/8"
2-1/4" x 4" x 8"

4 x 8 RELIEVED EDGE LUGGED PAVER

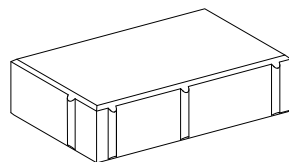

2-1/4" x 4" x 8"
*Lug sizes and configurations may vary.

2-5/8 x 4 x 8 RELIEVED EDGE LUGGED PAVER

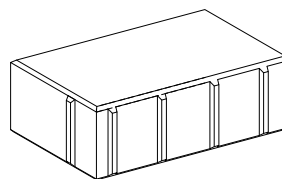

Effective: 2-5/8" x 4" x 8"
Actual: 2-7/8" x 4" x 8"
*Lug sizes and configurations may vary.

PAVER STEP TREAD

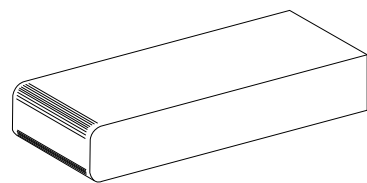

2-1/4" x 3-5/8" x 7-5/8"
2-1/4" x 3-5/8" x 11-5/8"

SPACERS

HERRINGBONE

Paver Spacers used in a herringbone application



RUNNING BOND

Paver Spacers used in a running bond application



BASKETWEAVE

Paver Spacers used in a basketweave application



ELIMINATING CHIPPAGE

In segmental paving applications, chippage often occurs when pavers move against each other due to improper installation techniques. Endicott paver spacers, however, eliminate this issue. They create and ensure the needed spacing between units to accommodate jointing sand while providing the crisp appearance of square edge pavers.

ESTIMATING DATA

HERRINGBONE PATTERN

10 'T' Spacers/sq. ft.

RUNNING BOND PATTERN

10 'T' Spacers/sq. ft.

BASKETWEAVE PATTERN

9 'T' Spacers/sq. ft.

1 '+' Spacers/sq. ft.

PAVER SPACER: CROSS

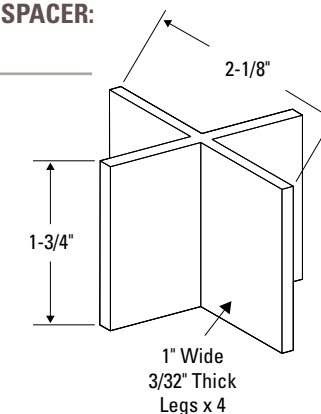

PAVER SPACER: TEE

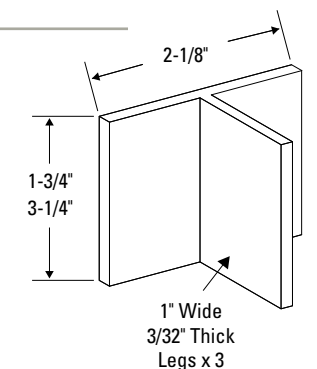

NOTE: Above sq. ft. quantities include perimeter spacers.

CREIGHTON UNIVERSITY ROUNDAABOUT



OMAHA
NEBRASKA



PROJECT DETAILS

COLOR

Burgundy Blend
Red Blend
Rose Blend
Medium Ironspot #77

SIZE/STYLE

2-5/8" x 4" x 8" Relieved/Lugged

CITADEL OUTLETS MALL



LOS ANGELES
CALIFORNIA



PROJECT DETAILS

COLOR

Medium Ironspot #46
Dark Ironspot
Medium Ironspot #77
Bordeaux Blend
Coppertone
Copper Canyon

SIZE/STYLE

4" x 8" Relieved Lugged

HARLEY STREETSCAPE



FORT WORTH
TEXAS

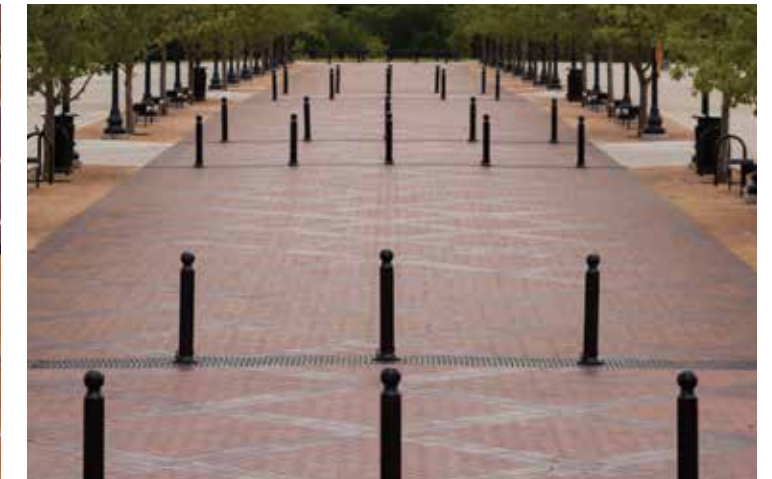
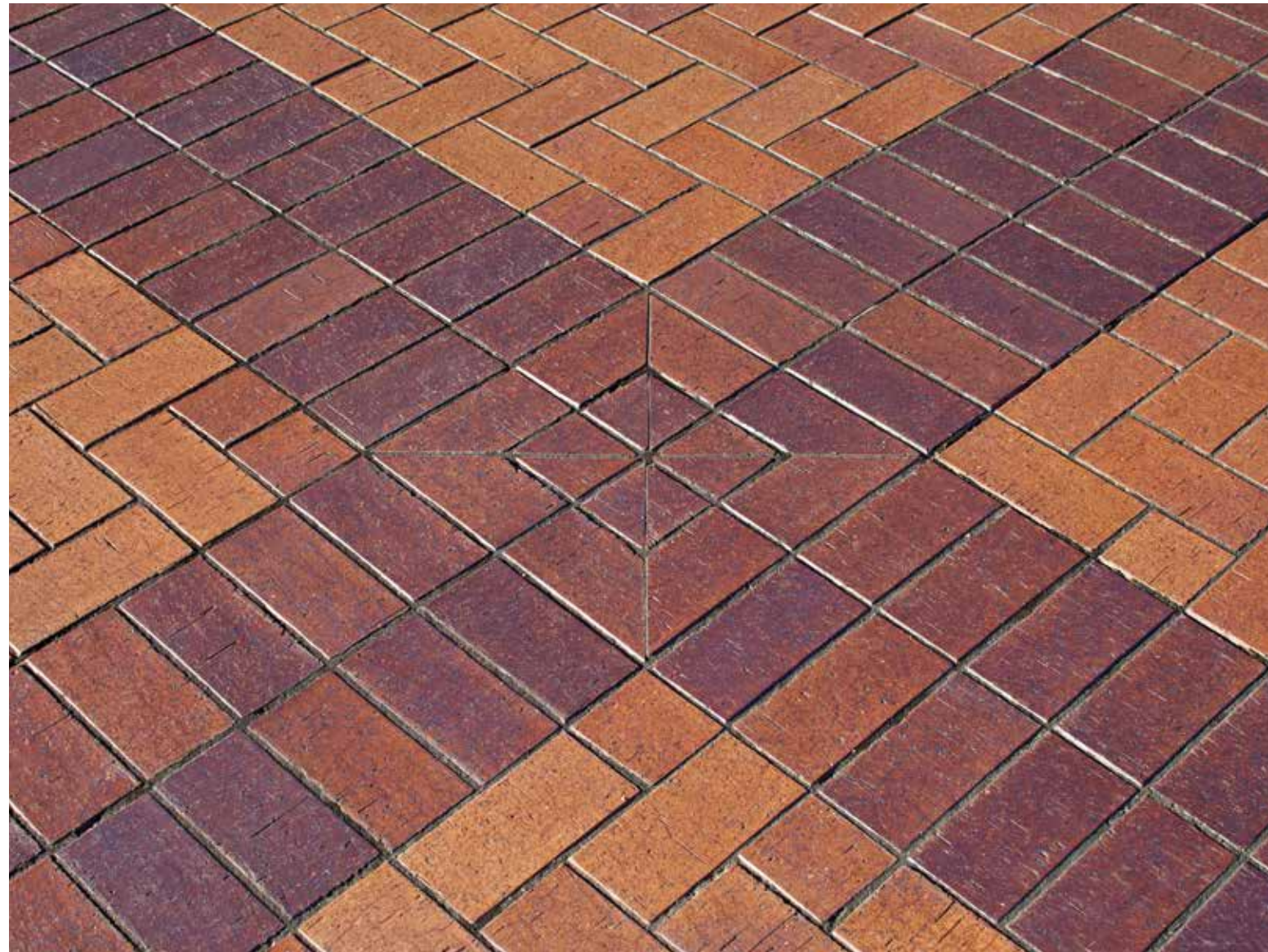

PROJECT DETAILS

COLOR

Medium Ironspot #46
Medium Ironspot #77
Manganese Ironspot

SIZE/STYLE

4" x 8" Relieved/Lugged
4" x 8" ADA



Endicott Clay Products Company

P.O. Box 17 Fairbury, Nebraska USA 68352

P 402.729.3315 F 402.729.5804

endicott.com



END-CPB-0222