

CLAY PAVERS



ENDICOTT™

This page intentionally left blank.

**SETTING THE SOLID WORLD
IN MOTION.**

Endicott clay pavers are the number one choice of designers who appreciate their aesthetic beauty, color retention and low maintenance requirements. They're fired at temperatures exceeding 2,000 degrees Fahrenheit, rendering them colorfast (non-fading) and resilient to wear and staining.

Unlike concrete pavers, Endicott's clay pavers do not require sealing. Due to their incredible durability, they last for decades and possess a sustainable natural color that looks great throughout their life.



PAVER COLORS



Rose Blend



Red Blend



Burgundy Blend



Bordeaux Blend



Coppertone



Copper Canyon



Medium Ironspot #77



Medium Ironspot #46



Dark Ironspot



Manganese Ironspot

Texture is wirecut for pavers and paver treads and smooth for pool coping.

PAVERS



VILLANOVA UNIVERSITY LANDSCAPE

Color: Dark Ironspot, Medium Ironspot #46, Manganese Ironspot, Medium Ironspot #77, Bordeaux Blend

Texture: Wirecut

Size: 2-5/8" x 4" x 8" Rel/Lug, 2-5/8" x 4" x 8" Permeable

Location: Villanova, PA



PAVER SIZES

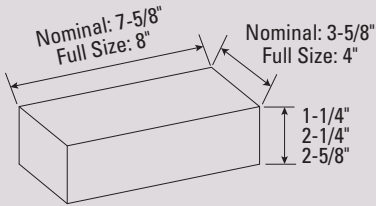

4" x 8" Paver

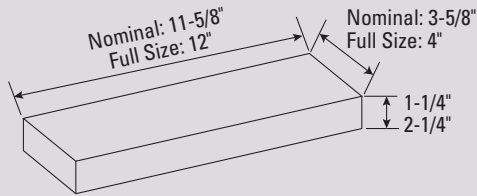

4" x 12" Paver

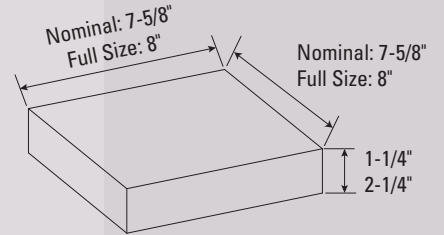

8" x 8" Paver

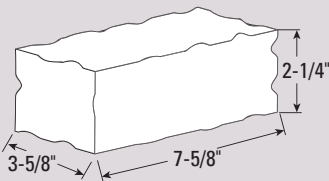

Danish Hand Mould

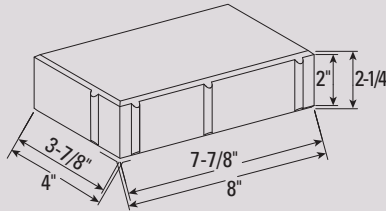

Relieved Edged Lugged Paver

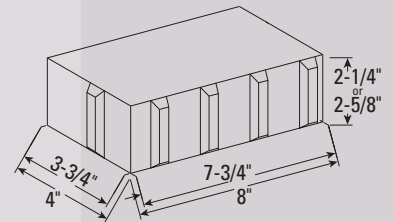

4" x 8" Permeable Paver

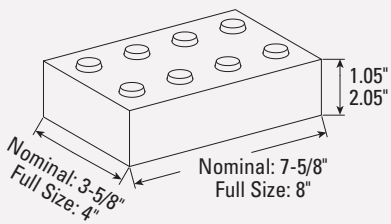

ADA Handicap Detectable
Warning Paver

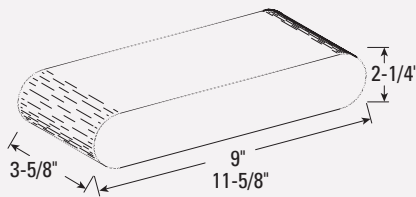

Pool Coping
Double Bullnose

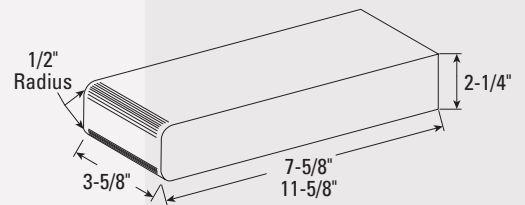

Paver Tread

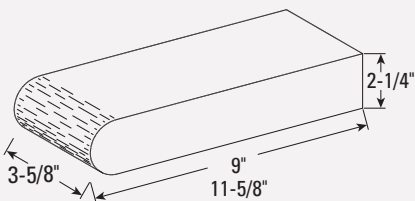

Pool Coping

PAVER SPACERS

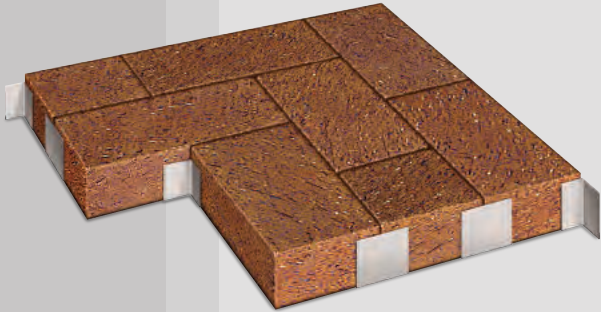

Paver Spacers used in a Herringbone application



Paver Spacers used in a Running Bond application

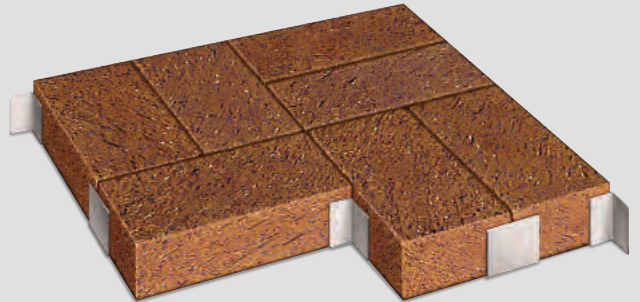

Paver Spacers used in a Basketweave application

ELIMINATING CHIPPAGE

In segmental paving applications, chippage often occurs when pavers move against each other due to improper installation techniques. Endicott paver spacers, however, eliminate this issue. They create and ensure the needed spacing between units to accommodate jointing sand while providing the crisp appearance of square edge pavers.

ESTIMATING DATA

Herringbone Pattern

10 'T' Spacers/sq. ft.

Running Bond Pattern

10 'T' Spacers/sq. ft.

Basketweave Pattern

7.5 'T' Spacers/sq. ft.

1.5 '+' Spacers/sq. ft.

NOTE:

Above sq. ft. quantities include perimeter spacers.

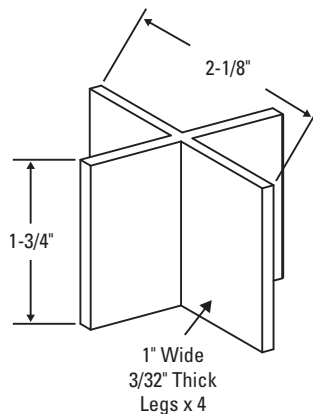

Paver Spacer—Cross

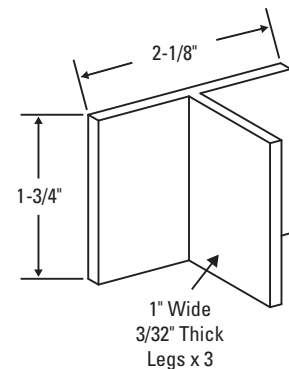

Paver Spacer—Tee



CHARLES E. LAK

HUMAN SERVICES CAMPUS



CHARLES E. LAKIN HUMAN SERVICES CAMPUS

Color: Burgundy Blend, Manganese Ironspot, Red Blend, Medium Ironspot #77, Desert Ironspot Dark

Size: 2-5/8" x 4" x 8" Lugged

Texture: Wirecut

Location: Council Bluffs, IA



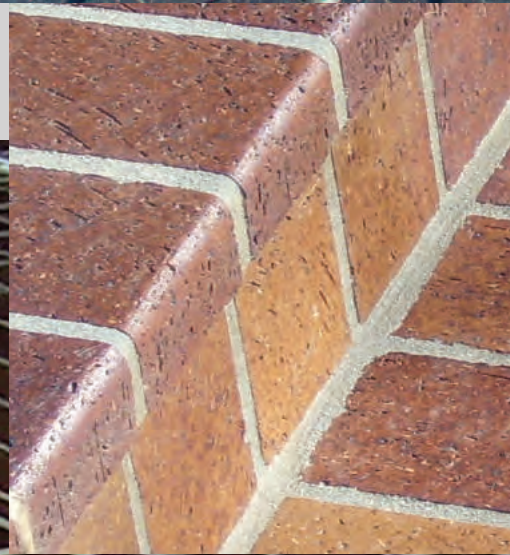



HARLEY AVENUE STREETScape

Color: Medium Ironspot #46, Manganese Ironspot, Medium Ironspot #77

Texture: Wirecut

Size: 2-5/8" x 4" x 8" Relieved Edge Lugged, 2-1/4" x 4" x 8" ADA

Location: Fort Worth, TX



PRIVATE RESIDENCE

Color: Medium Ironspot #46

Texture: Wirecut

Size: 2-1/4" x 4" x 8", Paver Step Tread

Location: Las Vegas, NV



PRIVATE RESIDENCE

Color: Dark Ironspot

Texture: Smooth

Size: Pool Coping

Location: Memphis, TN





PLAZA SAN CLEMENTE

Color: Coppertone, Medium Ironspot #46, Medium Ironspot #77, Dark Ironspot, Red Blend, Manganese Ironspot, Copper Canyon, Burgundy Blend

Texture: Wirecut

Size: 2-1/4" x 4" x 8" Relieved Edge Lugged, 2-1/4" x 4" x 8" ADA

Location: San Clemente, CA





CHERRY CREEK

Color: Medium Ironspot #77, Medium Ironspot #46, Dark Ironspot

Texture: Wirecut

Size: 2-1/4" x 4" x 8", 2-5/8" x 4" x 8" Relieved Edge Lugged

Location: Denver, CO







OUTLETS AT CASTLE ROCK

Color: Coppertone, Medium Ironspot #77, Medium Ironspot #46, Dark Ironspot

Texture: Wirecut

Size: 2-1/4" x 4" x 8" Relieved Edge Lugged, 2-1/4" x 4" x 8" ADA

Location: Castle Rock, CO



In 1920, rich mineral deposits were discovered in Jefferson County, Nebraska. These rich minerals help give Endicott clay pavers their unmatched color and resiliency. Across North America, Endicott's collection of face brick, thin brick, pavers, tile and special shapes are setting the solid world in motion.

For other literature, samples and the name of your nearest distributor, contact Endicott today.



Endicott Clay Products Company
P.O. Box 17
Fairbury, Nebraska USA 68352
402-729-3315 FAX: 402-729-5804
endicott.com

Citadel Outlet Malls
Color: Medium Ironspot #46, Desert Ironspot Dark
Desert Ironspot Light, Medium Ironspot #77, Bordeaux Blend
Texture: Wirecut
Size: 4" x 8"
Location: Los Angeles, CA